

Red Hat Ansible Automation Platform

A beginner's guide

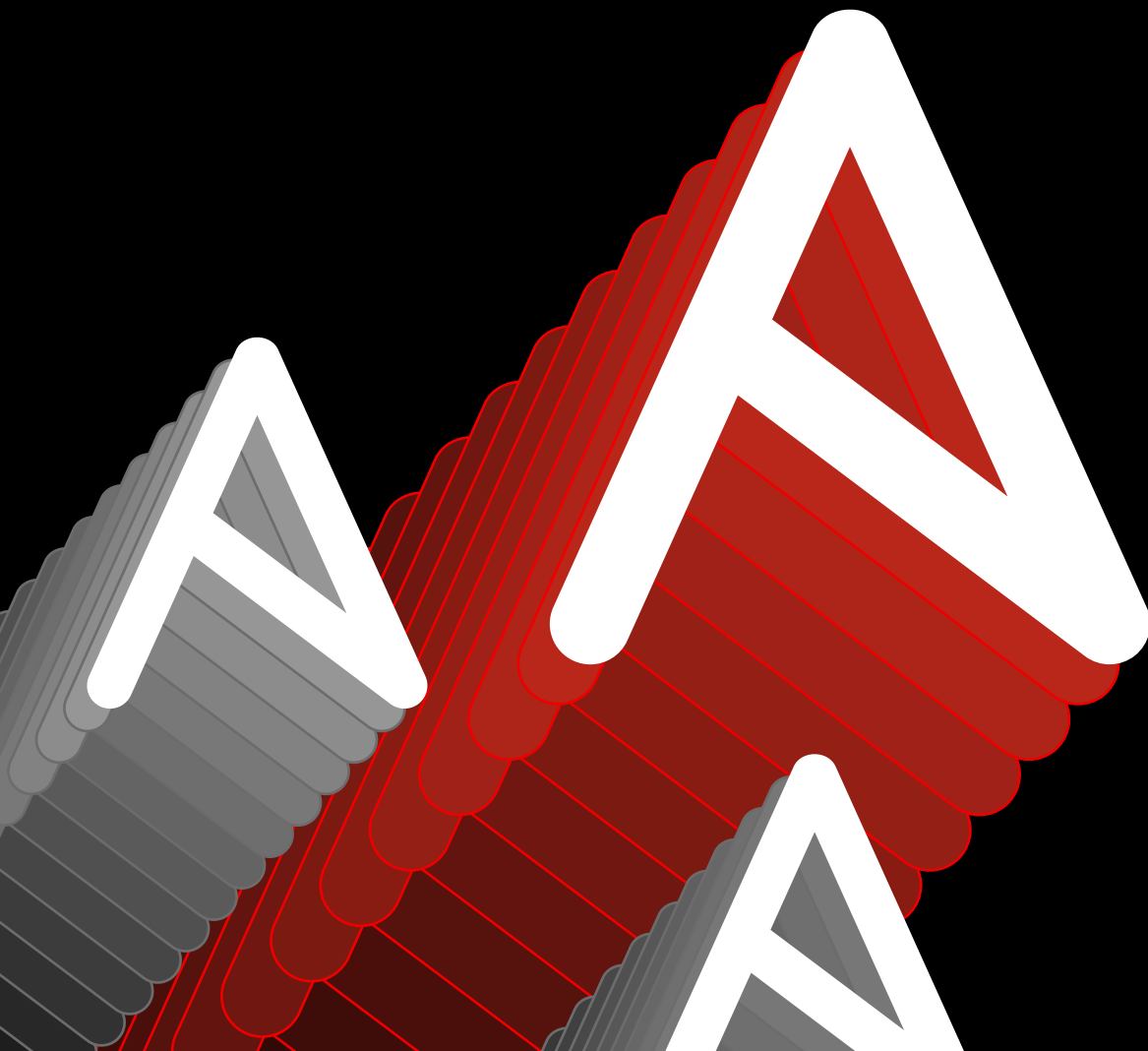

Choose the right path for your automation journey

Are you a newcomer to automation?

Start here and then jump into the chapters below to take you along your automation journey.

- 03** Introduction
- 06** A brief look at Red Hat Ansible Automation Platform
- 07** The business value of Red Hat Ansible Automation Platform
- 11** A closer look at Red Hat Ansible Automation Platform
- 14** A single platform for your entire automation team
- 20** Where to integrate automation into your organization
- 30** How to get started

Do you have some experience in automation?

Start here and then jump into the chapters below to take you along your automation journey.

- 03** Introduction
- 25** The benefits of Red Hat Ansible Automation Platform partnerships
- 27** Strategies for automation adoption
- 31** Taking the next step

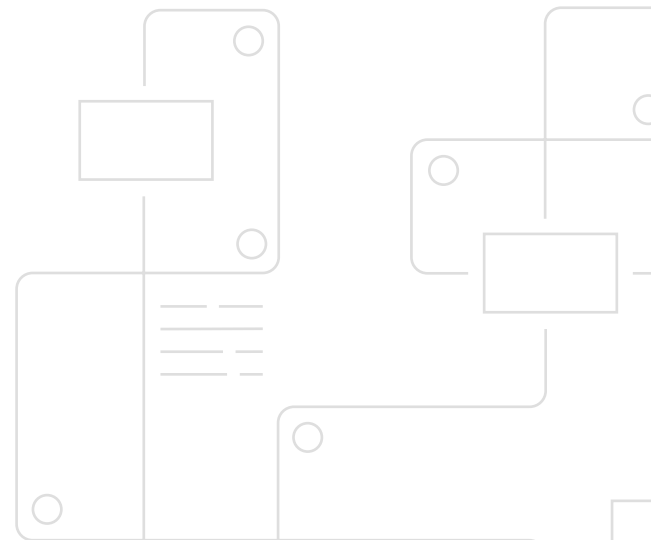

Introduction

IT automation is now mission critical.

Modern enterprises struggle with overwhelming IT complexity while under pressure to extract more return on investment (ROI) from existing technology investments. Spending their way out of the problem isn't a solution.

In order to be competitive and increase revenue, IT teams need to bring more services to market faster, allowing IT teams to be more productive and efficient, and maintain a focus on the security and compliance of operating environments and systems—all with the same resources available to them.

At an operational level, organizations deal with disconnected teams, skill gaps, and a lack of consistent governance. At a technical level, IT departments manage too many tools that do similar things, leading to solution sprawl and bloated budgets. Instead of being focused on growth, scale, and innovation, IT manages outdated manual processes.

Although many organizations dabble in automation, too many approach it in a task-based way with point solutions rather than taking a broader view. A task-based approach can increase costs, result in duplicate efforts, require expertise on multiple platforms, and build barriers between functions and departments. Many companies strive to use automation more strategically across their organizations, and automating IT functions is key to their success. In fact, 451 Research found the number of companies with automated IT processes was expected to rise from 7% of companies to 20% of companies within a year.¹

While this is progress, many organizations have a long way to go to achieve this. Promising technologies—such as generative artificial intelligence (gen AI)—can't fix a slow or broken IT process or offset the inefficiencies from manual provisioning and IT management tasks. Even with automation in place, overworked IT teams still spend too much time on Day 2 operations, such as system patching, service ticket resolution, security issue remediation, and root cause analysis.

Automating strategically is the way to truly get ahead. In order for organizations to participate in and benefit from artificial intelligence (AI) and automation, they need to have a strong automated IT operations foundation in place, with an approach that is simultaneously focused on technologies, processes, and people.

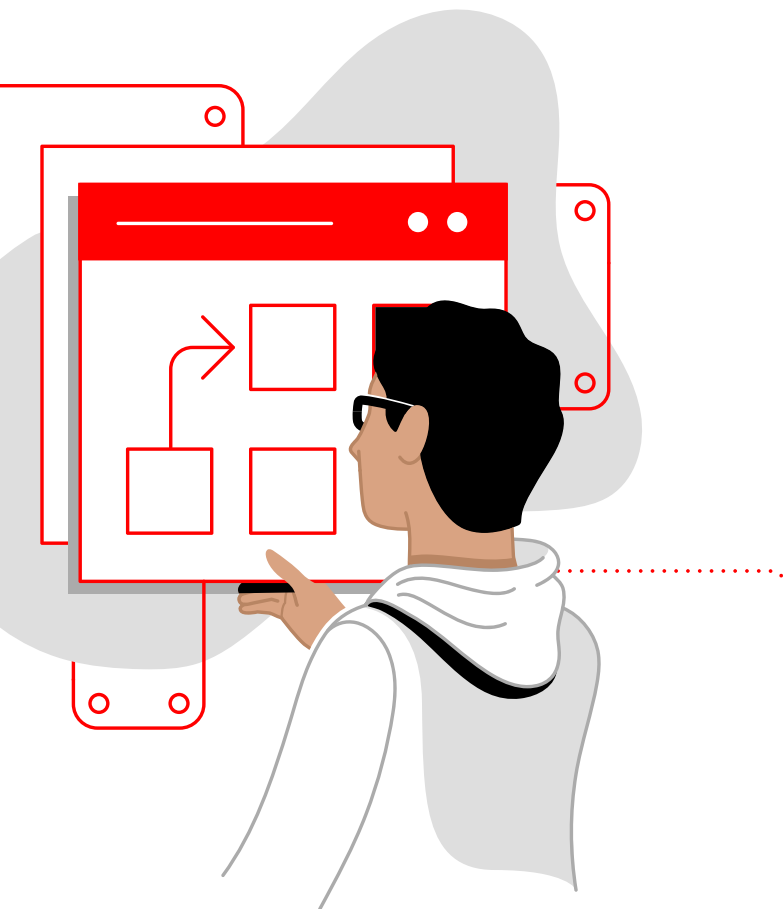

¹ 451 Research. "The impact of event-driven automation on IT operations," 7 Oct. 2022.



What should IT automation look like?

- Accessible across users, teams, and regions.
- Ability to respond with agility to evolving business needs.
- Optimized productivity and efficiency of IT teams.
- Faster IT service response times.
- Coordinated workflows across the IT environment, including datacenter, clouds, operating system (OS), applications, networking, IT service management (ITSM), security systems, and edge devices.
- Adherence to internal governance policies and service-level agreements (SLAs).
- Use of advanced event-driven automation techniques to proactively prevent issues.
- Proactive remediation of security and compliance risks across all aspects of IT.

The right automation solution can improve the way IT functions in your organization while unifying teams and processes, and ultimately, transforming the way you deliver IT. **So what does it take to bring IT automation to your organization?**

Red Hat® Ansible® Automation Platform is a flexible, scalable, and comprehensive automation solution that works across your IT environment and meets you where you are in your automation journey. With Ansible Automation Platform, automation is accessible, shareable, and usable across teams and departments, with seamless integration into your existing IT systems and platforms.

*Automation generates substantial day-to-day efficiencies ... Development teams benefit from greatly reducing the friction associated with provisioning and deploying the IT resources they require. Employees benefit from higher-quality applications that experience fewer outages."*²

Jevin Jensen, Research Vice President, Infrastructure and Operations, IDC

² IDC Business Value White Paper, sponsored by Red Hat. "[The Business Value of Red Hat Ansible Automation Platform](#)." Document #US51839824, March 2024.

With the addition of Event-Driven Ansible and the AI-powered Red Hat Ansible Lightspeed with IBM watsonx Code Assistant, your Ansible Automation Platform investment extends even further.

Event-Driven Ansible:

This event-driven automation tool can help your business maintain resilience, reliability, and efficiency while working around resource constraints and skills gaps.

Ansible Lightspeed with watsonx Code Assistant:

This gen AI tool can help your automation teams create, adopt, and maintain Ansible content faster and more efficiently.

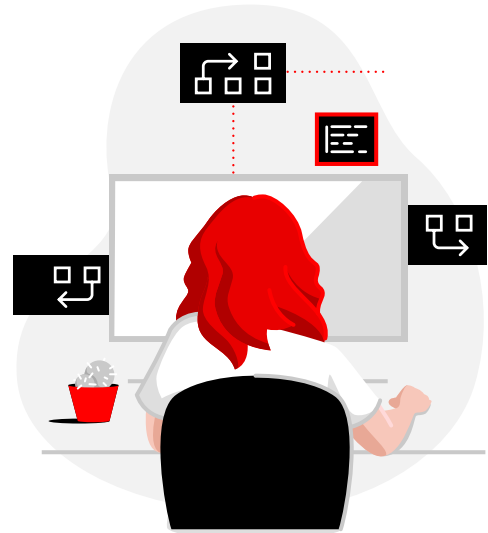

Use this e-book as your guide to Ansible Automation Platform, its benefits, and information to help you make the right decisions for your organization's automation practice.

If you have used Ansible Automation Platform before

and want to learn about the benefits of extending automation across your organization or migrating from an earlier version to the latest offering, jump to **A closer look at Red Hat Ansible Automation Platform.**

If you're brand new to Ansible Automation Platform

keep reading to find out how automation can help your organization succeed.

Let's get this journey started.

A brief look at Red Hat Ansible Automation Platform

To understand Ansible Automation Platform, you first need to understand Red Hat. For more than 25 years, Red Hat has delivered open source solutions hardened for stability that help organizations work across platforms and environments and address enterprise IT challenges. Red Hat has a long history of participating in open source community projects, and the work around Ansible Automation Platform is no exception.



60K stars³

Ansible/Ansible



31.6K users³

Ansible/Ansible



5,500+ contributors³

Ansible/Ansible



70.5K followers⁴

Red Hat Ansible X (formerly Twitter)

A vibrant and enthusiastic community of people contributes to and relies on the Ansible project, and they continue to extend this technology into a more flexible and robust solution every day, with upstream developers helping expand its ability to support enterprise ecosystems.

Red Hat is evolving the platform to meet the ongoing complexities of hybrid and multicloud computing and be flexible enough to meet future challenges. At the same time, Red Hat is committed to helping the Ansible community to grow and thrive.

See how Ansible Automation Platform helps organizations adopt a culture of collaborative automation.

[Watch the video.](#)

Find out how Red Hat Ansible Automation Platform can bring tangible business benefits to your organization by reading [The business value of Red Hat Ansible Automation Platform.](#)

³ "GitHub - Ansible." GitHub, accessed 2 Feb. 2024.

⁴ "X - Red Hat Ansible." X, accessed 2 Feb. 2024.

The business value of Red Hat Ansible Automation Platform

Investments in automation are being prioritized across many areas, according to Red Hat's 2023 Global Tech Outlook.⁵ The report found 29% of respondents said IT operations automation is a top IT technology funding priority over the next year, up 1 percentage point from the previous year's research.

Over the next 12 months, what are your company's top IT technology funding priorities? (Select up to 3)

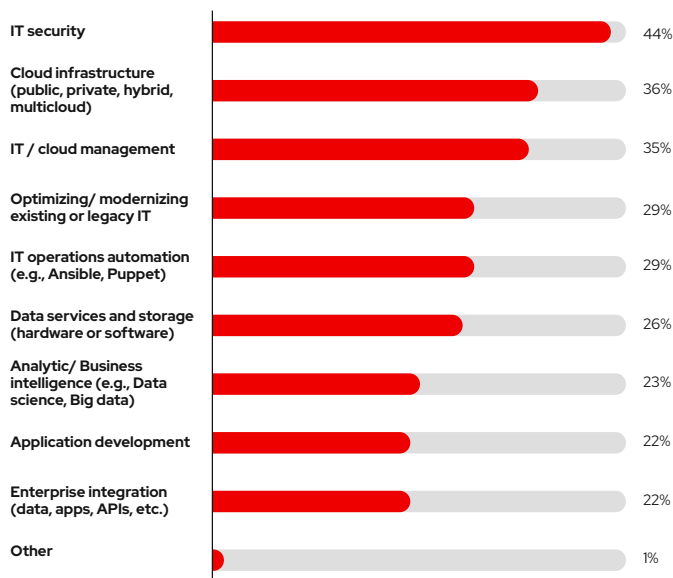

Why is automation gaining traction year over year?

There are a number of potential reasons, but among the biggest is the quantifiable business value of automation—and particularly of Ansible Automation Platform.

According to research from IDC, customers using Ansible Automation Platform to support business needs and to improve IT and application development operations could see a 3-year return on investment (ROI) of 668% with an 8-month payback on investment.⁶

Want to find out more about how to champion IT automation across your organization?

Read the [IT executive's guide to automation](#).

⁵ Red Hat overview. "2023 Global Tech Outlook: A Red Hat report," 15 Nov. 2022.

⁶ IDC Business Value White Paper, sponsored by Red Hat. "The Business Value of Red Hat Ansible Automation Platform." Document #US51839824, March 2024.

Based on interviews with Ansible Automation Platform users, the report also found that organizations could benefit from positive effects on:⁷

Reliability:

- **61%** reduction in unplanned downtime.
- **27%** more efficient IT security teams.

IT staff:

- **38%** more efficient network infrastructure management teams.
- **36%** more productive development teams.

DevOps efficiencies by activity:

- **38%** improvement in provisioning.
- **34%** improvement in configuring.
- **27%** improvement in securing.



⁷ IDC Business Value White Paper, sponsored by Red Hat. "[The Business Value of Red Hat Ansible Automation Platform](#)." Document #US51839824, March 2024.

Organizations around the globe, such as [Swisscom](#), [Agile Defense](#), and [Ulta Beauty](#), are finding similar business benefits using Ansible Automation Platform.

From improving efficiencies and delivering digital services faster to freeing up critical resources to focus on higher-value projects, these organizations are recognizing the advantage of taking a holistic automation approach.



Red Hat Ansible Automation Platform gives us a lot of flexibility and covers a lot of different patterns. It also integrates well with our other tools.”⁸

Giancarlo Morena, Product Manager, Swisscom

We chose Red Hat Ansible Automation Platform to tackle this problem because it can communicate with everything.”⁹

Sara FitzGerald, PhD, Technical Writer, Agile Defense

The built-in capabilities of Red Hat Ansible Automation Platform provide an accelerator in a box. It’s the de facto standard that many of our vendors and partners also use to write scripts to install, configure, and maintain their technology.”¹⁰

Jesse Amerson, IT director, Ulta Beauty

⁸ Red Hat case study. [“Swisscom gains efficiency by standardizing and expanding automation,”](#) 6 Dec. 2023.

⁹ Red Hat case study. [“Agile Defense simplifies security compliance with automation,”](#) 22 Jan. 2024.

¹⁰ Red Hat case study. [“Ulta Beauty Standardizes on Red Hat for Automation and Service Delivery Transformation,”](#) Oct. 2022.

3 advantages of implementing Ansible Automation Platform in your organization:

1 Greater efficiency:

Your staff can spend more time making a bigger impact on your business. Leave the rote repetition to automation.

2 Better reliability:

When you reduce human intervention, you encounter fewer oversights and issues because everything happens in the same way—every time. Have confidence that you know exactly when processes, tests, updates, workflows, and other tasks are going to happen, how long they'll take, and that you can trust the outcomes.

3 Simplified governance:

Minimize the potential consequences of knowledge gaps. With a holistic automation approach, you have better control over your entire organization and an improved vantage point over any missed steps, not to mention audit trails and other information you need to easily align with compliance goals.

Learn more about the value of the Ansible Automation Platform.

[View video.](#)

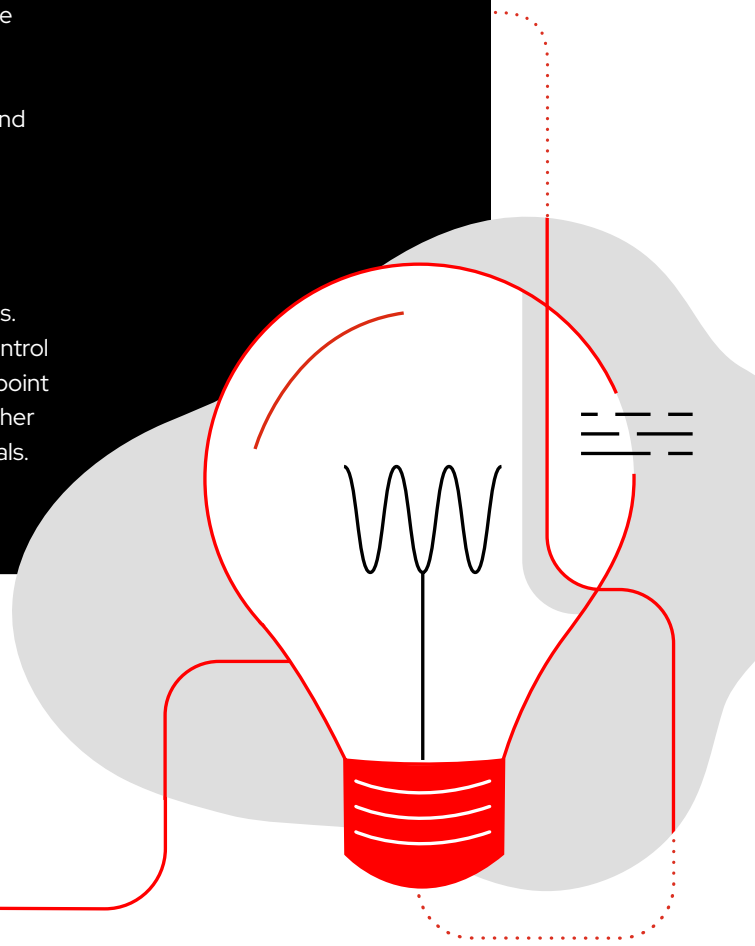

Now that we've looked at the benefits of using Ansible Automation Platform, it's time to explore how to access those benefits, including some of the top features of the platform. Jump to [A closer look at Red Hat Ansible Automation Platform.](#)

A closer look at Red Hat Ansible Automation Platform

Whether you want to automate applications, networks, containers, security, cloud infrastructure, or all of the above, Ansible Automation Platform can help you create, execute, and manage automation—all from a single place.

1

Ansible Automation Platform uses playbooks in YAML format.

Ansible Playbooks are regularly used to automate administration functions, such as orchestration, configuration, management, and deployment. A playbook is written in the YAML syntax and contains 1 or more plays, which are used to define a web service or an application. YAML is human-readable and easy to understand, and it can be used in conjunction with other programming languages, such as Ruby, Python, or Bash.

Each play within a playbook can run 1 or more tasks, and each task invokes an Ansible module, which are used to accomplish automation tasks in Ansible Automation Platform.

Because Ansible Automation Platform uses the easy-to-use YAML syntax—which comes in plain text, human-readable language and benefits from source control management—users who don't write programming language code can automate infrastructure with confidence. Note that Event-Driven Ansible uses rulebooks instead of playbooks, also written in YAML, that contain conditional if-then rules to push the right user-defined automated actions. These rulebooks are able to call existing Ansible Playbooks, too.

Want to learn more about YAML?
Check out this [topic page](#) for
more information.

2

Ansible Automation Platform features gen AI.

[Ansible Lightspeed with IBM watsonx Code Assistant](#) is a gen AI service designed to help individuals and teams create, adopt, and maintain Ansible content with more ease and efficiency. With Ansible Lightspeed with IBM watsonx Code Assistant, new automation content creators can learn faster while experienced developers can validate their code to promote adherence to Ansible best practices.

Connected to the IBM watsonx Code Assistant service, Ansible Lightspeed turns natural language prompts into recommended code snippets—in the form of tasks that can be used as part of a playbook—while integrating directly into existing developer workflows, helping to bridge the gap between automation ideas and Ansible content.

3

Ansible Automation Platform is agentless.

Among the most powerful and unique features of Ansible Automation Platform is the fact that it's agentless, which means that you don't need to install an agent on any machines you are trying to manage. This feature makes Ansible Automation Platform extremely scalable, as it can rapidly manage multiple machines or systems simultaneously.

4

Ansible Automation Platform is built for the hybrid cloud.

As hybrid and multicloud computing models continue to expand, IT organizations need automation platforms that can bridge from traditional systems to modern services to the far edge of the network.

To make your automation projects highly portable and scalable, Ansible Automation Platform includes automation execution environments. Execution environments help create self-contained automation that packages all dependencies needed to build, run, and manage automation across hybrid and multicloud infrastructure and to the edge of the network.

Whether you're modernizing and moving workloads to the cloud, implementing DevSecOps, or finding new ways to manage a growing network of edge devices, Ansible Automation Platform is able to fulfill diverse needs across multiple processes. Ansible Automation Platform is now available directly through several of the leading hyperscalers' marketplaces, making it even simpler to start automating across your cloud environments and efficiently integrate with the cloud services you are already using.

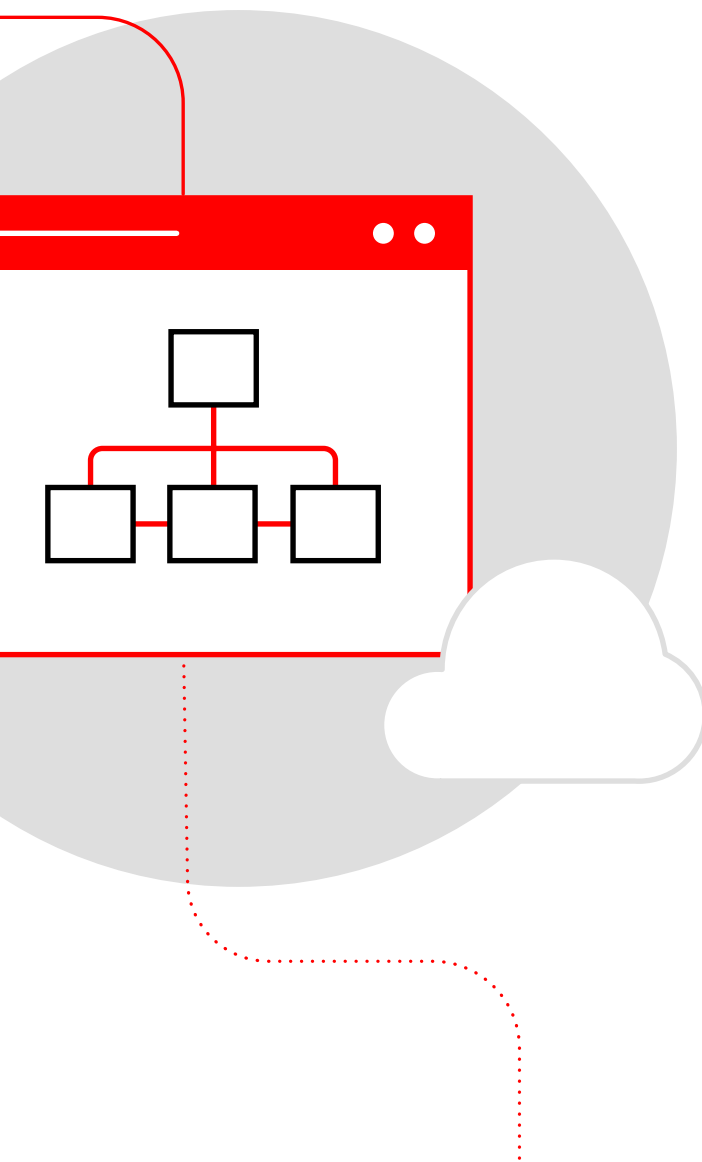

5

Ansible Automation Platform has built-in compliance and governance constructs.

From role-based access controls (RBAC) that allow administrators to assign permissions, privileges, and roles to users to encryption, audit trails, and inventory controls, Ansible Automation Platform has the tools necessary to keep your organization compliant and aligned with SLAs.



6

Ansible Automation Platform includes event-driven automation.

Event-driven automation is the next step in the journey to end-to-end automation. It answers the need to connect intelligence, analytics, and service requests for an IT environment to automated actions so that activities can take place in a single motion. This model is ideal for high-volume, routine tasks and ITSM actions, along with responding to changing IT conditions, and more.

Event-driven automation works by allowing for a predefined and automated response when a certain type of event occurs. For example, in a typical IT operation, a system outage can send an alert that automatically triggers a specific action like logging a trouble ticket, gathering the facts needed for troubleshooting, or performing a task, such as a reboot—all without manual steps. In a similar way, event-driven automation can help teams respond to a variety of additional Day 2 operational needs, such as configuration management, edge device management, provisioning, user management, tuning and scalability, and more.

These are only a few of the features and benefits that you can expect from Ansible Automation Platform. [Learn more](#) about how Ansible Automation Platform brings teams and systems together.

If you have used Ansible Automation Platform before

and want to delve into what you can automate, jump to [Where to integrate automation in your organization](#).

If you're new to Ansible Automation Platform

move on to [A single platform for your entire automation team](#).

A single platform for your entire automation team

Ansible Automation Platform is designed to help set up your entire automation team for success.

Breaking down barriers between systems and teams across the organization, Ansible Automation Platform gives diversified teams the automation tools they need for their specific roles while collaborating with a connected, supported, and security-focused enterprise-wide solution.

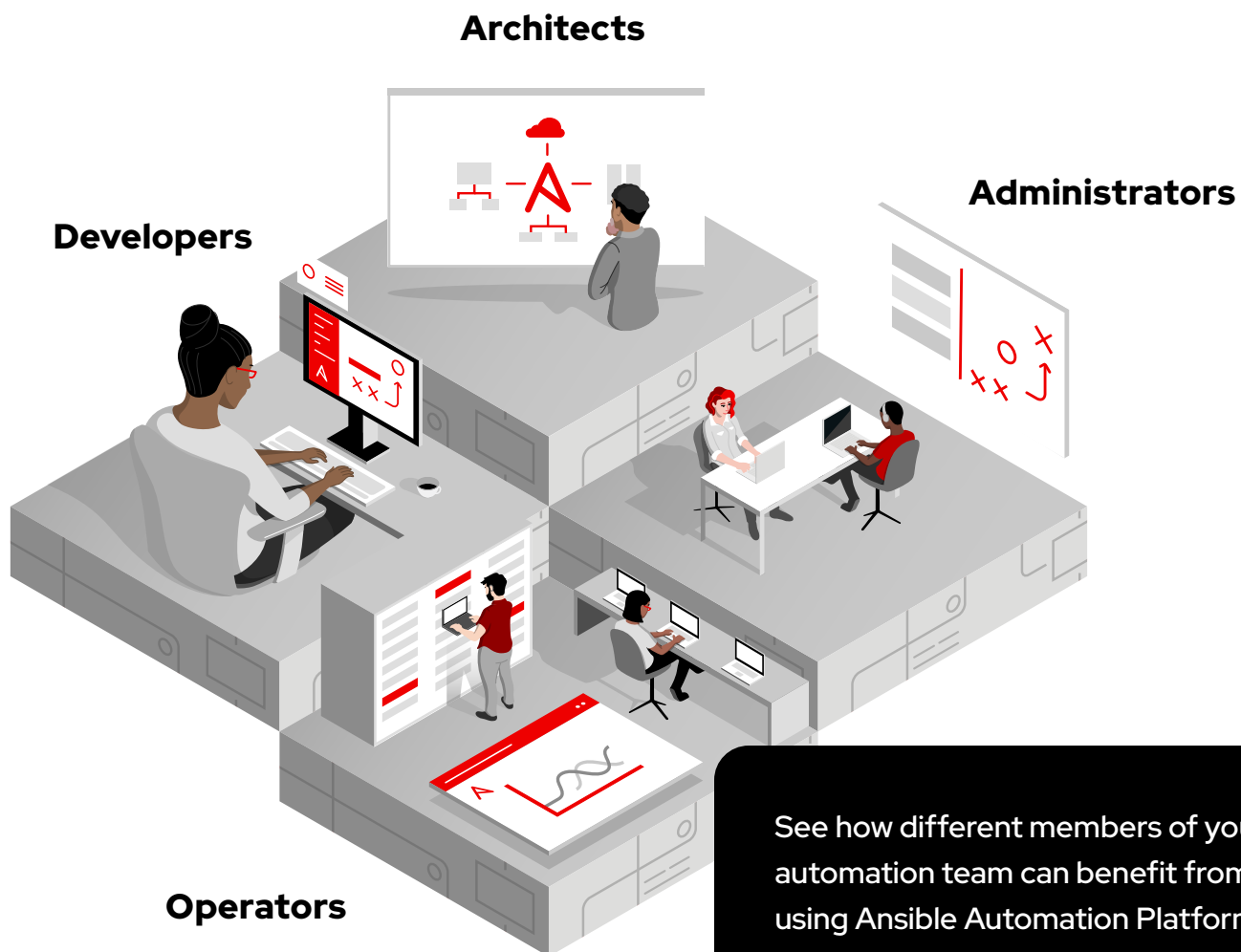

See how different members of your automation team can benefit from using Ansible Automation Platform:

Automation platform engineers and developers

Automation developers need tools that can help them create Ansible Playbooks, [Ansible Roles](#), and modules, and then test them locally to see if they run the same way when moved to production. Automation developers can benefit from DevOps

tooling and plug-ins, access to pre-existing certified content to build from, and container-native architecture for both building and testing.

The right tools for automation platform engineers and developers



Automation execution environments:

Automation execution environments provide automation developers with a consistent environment from development to production, which means developers can focus on the automation content itself without worrying about dependencies and drift between each stage.



Ansible content tools:

The execution environment builder helps automation developers build custom automation execution environments with the precise Ansible content and dependencies needed to support their automation. The automation content navigator lets users run and validate the content they create within the context of the execution environment itself.



Ansible development tools:

Ansible development tools are a suite of command-line features and other capabilities that help Ansible content creators confidently build, test, and deploy automation content in the enterprise. Even less experienced users can create test environments, analyze playbooks, deploy content inside execution environments, and more with these supported tools.



Ansible Content Collections:

Ansible content can be created and managed internally for your organizations to use. However, curated content is also available from Red Hat through Ansible Content Collections. These collections provide developers with the option of building on curated automation content, which includes more than 100 certified collections and more than 40,000 modules.



Ansible automation hub:

This hosted service is the place for users to find and use supported Ansible Content Collections, which contains modules, roles, and plug-ins, along with the documentation you need to get started.



Ansible Lightspeed with IBM watsonx Code Assistant:

Ansible's gen AI experience is designed to enhance the Ansible playbook development process, bridging the gap between your automation ideas and the functional YAML code you need to make Ansible Playbooks. You can accelerate automation content creation and validate the code you write with an AI model trained specifically on Ansible best practices.

Automation architects

Tasked with streamlining automation adoption and elevating automation across teams to align with IT processes, automation architects need tools that can not only expand automation across the organization but that can also help to manage automation policy and governance. Ansible Automation Platform provides container-native architecture,

which offers flexibility when automation architects must plan for current and future needs. Additionally, automation architects benefit from Ansible Automation Platform's agentless framework, along with the entire Ansible technology ecosystem, which integrates efficiently with existing IT investments.

The right tools for automation architects



Automation execution environments:

Automation execution environments represent a change in architecture for Ansible Automation Platform. By separating the control plane and the execution plane, Ansible Automaton Platform can provide better scalability. For example, networking or cloud teams have their own standardized execution environment specific to their needs while developers have a standardized environment that frees them from worrying about dependencies.



Automation controller:

Automation controller standardizes how automation is initiated, delegated, audited, and deployed, allowing organizations to automate with confidence and reduce automation sprawl and variance across the enterprise. This management interface also decreases the complexity of your automation efforts and prevents drift between development and production.



Red Hat Ansible Certified Content Collection:

This prebuilt collection of automation content allows developers to build on what already exists and helps operations teams make the most of existing automation, accessible through the Ansible automation hub hosted service. Curated content that is developed in-house and from Red Hat and other sources can be made available through private automation hubs as well.





Ansible validated content:

This collection of pre-built YAML content is targeted at the most common automation use cases but also customizable for your organization's specific use cases. While it is not supported or maintained by Red Hat, all Ansible validated content is delivered by trusted industry partners, and is digitally signed, so you can be confident that the collection came from a trusted source.



Automation mesh:

Automation mesh provides a flexible and reliable way to scale the automation of large inventories across diverse network topologies, platforms, and teams. Architects require a solution that meets all of their current requirements and can scale to address future needs, all while integrating with current technologies and providing support and adherence to SLAs. Automation mesh helps architects by creating a layer to connect networks and environments in a way that provides flexibility without compromising focus on security.



Event-Driven Ansible:

This is a highly flexible solution used to create advanced end-to-end automation scenarios for a wide variety of needs across your IT operations. It can help increase efficiency, resolve issues quickly, and help alleviate staffing and skills challenges. As part of Ansible Automation Platform, it is designed for simplicity and ease of use. For example, you can use familiar YAML syntax to create Ansible Rulebooks, which are similar to Ansible Playbooks but use if-then scenarios instead.



Automation analytics and Red Hat Insights for Ansible Automation Platform:

Automation analytics and Red Hat Insights help architects better understand automation adoption and performance across the organization. With automation analytics, you can predict and measure time savings with automation, as well as ROI. With Red Hat Insights, teams can proactively remediate performance, security, and other issues, as well as identify configuration drift across their Ansible Automation Platform infrastructure.



Learn more about how automation architects can build with an automation-first mindset in [*The automation architect's handbook.*](#)

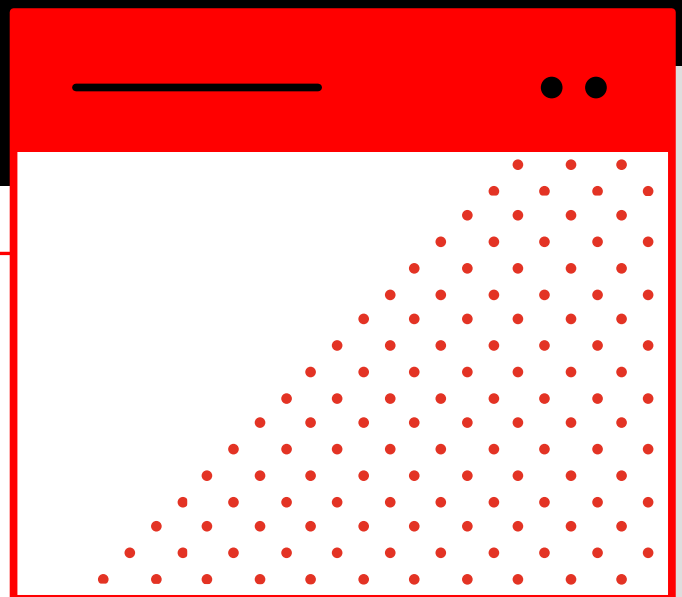

System or cloud operators and administrators

System or cloud operators need to automate with speed and efficiency, so understanding what prebuilt, certified content is available is essential.

Ansible Automation Platform provides architecture and tooling that support standardization, compliance, and governance to help manage automation teams at scale.

Charged with reliably configuring, deploying, running, and managing automation for multiple teams and applications inside their organization, administrators need a solution that's simple. Ansible Automation Platform is designed to be consistent and highly reliable, with a shallow learning curve for new users. Administrators benefit from using both hosted service and private versions of the automation hub, where content is centrally shared and managed, and real-time analytics and reporting using Red Hat Insights for Red Hat Ansible Automation Platform.

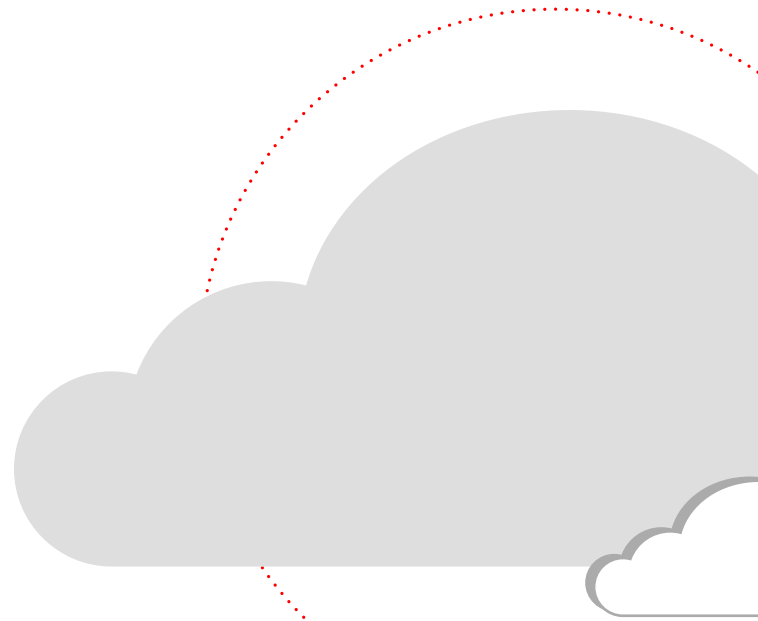

The right tools for system or cloud operators and administrators



Automation controller:

All automation team members interact with or rely on the automation controller, and it's up to administrators and operators to ensure the automation platform and framework are operational. Their administrative tasks are aided by automation controller's user interface, browsable application programming interface (API), RBAC, job scheduling, integrated notifications, graphical inventory management, continuous integration/continuous delivery (CI/CD) integrations, and workflow visualizer functions.



Ansible automation hub:

Ansible automation hub is a portal that gives users direct access to trusted content collections from Red Hat and certified partners. This Software-as-a-Service (SaaS) automation hub is a container image repository serving cloud environments that is synchronized with the automation controller through a container registry credential.



Private automation hub:

The execution environment container image repository for Ansible Automation Platform—the private automation hub—is hosted locally. It is intended for organizations running Ansible Automation Platform on physical or virtual machines.



Automation analytics and Red Hat Insights for Ansible Automation Platform:

Automation analytics and Red Hat Insights help you better understand automation adoption and performance across the organization. With automation analytics, you can plan and measure time savings with automation, as well as ROI. With Red Hat Insights, you can proactively remediate performance, security, and other issues, as well as identify configuration drift across their Ansible Automation Platform infrastructure.



Automation mesh:

Automation mesh helps operations teams deliver services at the ever-increasing pace of their organization without having to understand the details of the automation foundation itself. Automation mesh manages dependencies and scales consistently without requiring knowledge of ancillary tools. The automation mesh architecture allows central control and distributed execution through execution nodes, moving automation closer to the endpoints and allowing a flexible architecture that can adapt to a customer's specific needs.



Event-Driven Ansible:

Event-driven automation can be used to automatically complete tasks across your environment, including routine management needs, issue remediation, and automated responses, such as self-service. Tasks performed hundreds or thousands of times across your organization are great candidates for automation, such as management of storage or capacity associated with a key application, continual tweaks to an essential underlying technology, or proactively addressing security risks.



Ansible Lightspeed with IBM watsonx Code Assistant:

This gen AI service helps you create Ansible playbooks with more ease and efficiency, while delivering the accuracy, transparency, and data protections that your organization needs to be able to trust AI-generated code. You can write Ansible code faster using gen AI capabilities infused with Ansible expertise and best practices.

Ansible Automation Platform is available through many of the leading hyperscalers' marketplaces, making it even easier to adopt automation across your public and hybrid cloud environments.

Now that we've explored who uses automation, let's look at where and how they might use it. Jump to [Where to integrate automation into your organization](#).

Where to integrate automation into your organization

Regardless of where you might be on your automation journey, Ansible Automation Platform is designed to help you:

Accelerate

Work faster with the power of Ansible's massive open source community and prebuilt content collections of the most-used Ansible Roles and modules. Codify your infrastructure and share across teams and environments where you're already running deployments, whether on-premise or in the cloud.

Innovate

Take automation even further with analytics, policy and governance, and content management. Ansible Automation Platform provides tools that make day-to-day work more efficient, helping you solve problems once and share the results with everyone.

Orchestrate

Efficiently transfer your automation into multiple domains and across different use cases and teams without slowing down development time.

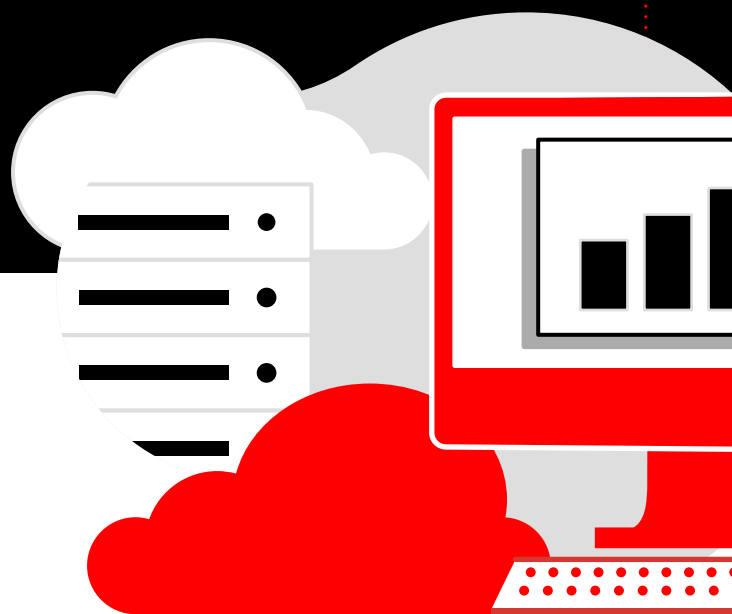

Some of the top areas where organizations implement automation across their enterprise include:

1 Infrastructure automation

Build, provision, and manage applications and infrastructure across public or private clouds, containers, and virtual environments, including Red Hat Enterprise Linux®, Microsoft Windows and Windows Server, other Linux distributions, VMware vSphere, ServiceNow ITSM, SAP, and others. Automate your infrastructure to mitigate configuration drift and incorporate repeatability of code. Benefit from event-driven automation, which can be used to improve efficiency and responsiveness by reducing high-volume repetitive tasks that are part of IT operations. Tasks that are performed many hundreds or thousands of times across your organization—such as fact gathering, ticket enhancement, and configuration management—are good candidates for event-driven automation.

Find out how to [streamline CI/CD pipelines](#) with Ansible Automation Platform

2 Network automation

Manage entire network and IT processes across physical, software-defined, and cloud-based networks. Use network automation for:

- **Configuration management.** Back up and restore network devices from multiple vendors and move toward the next generation of network management by using an infrastructure as code (IaC) approach to automate network operations.
- **Infrastructure awareness.** Collect network facts automatically from hundreds or thousands of multivendor devices and then normalize this information to learn which devices and resources need preventative maintenance to avoid outage risks and unnecessary hardware refreshes.
- **Network validation.** Examine the operational state of your network devices to check for connectivity and protocols in use, and align them with specific network compliance requirements.
- **Event-driven network management.** Event-Driven Ansible connects sources of events with corresponding actions using rules. Its decision-making capabilities receive an “event” from a monitoring tool and trigger the required action. You can automatically respond to suspected security risks, manage configurations, or apply event-driven automation to the above network management tasks.

Read [Network automation guide](#) to learn more



3 Cloud automation

Use Ansible Automation Platform to provision instances, networks, and infrastructure with support modules that ensure deployments work across public and private clouds, whether deployed on-premise or in the cloud. Event-driven automation can then use Ansible Rulebooks to define the source of an event and explain the action to take—in the form of if-this-then-that instructions—when the event is encountered. It can help manage cloud instances, allocate or deallocate resources, update access policies, enforce governance, and more.

Read [Automate your hybrid cloud at scale](#) to learn more about cloud automation

4 Security automation

Orchestrate security systems using a curated collection of modules, roles, and playbooks to investigate and respond to threats. Coordinate your enterprise security systems with Ansible Automation Platform for investigation enrichment, threat hunting, and incident response. You can quickly respond to security risks before your environments are adversely impacted, or even close down a technology or solution while you investigate. As a result, event-driven automation can help you boost IT resilience.

Learn more about security automation in this e-book: [Simplify your security operations center](#).

5 Edge automation

Using Ansible Automation Platform at edge sites takes IT automation out of the datacenter and to the edge devices and workloads that are being automated. Ansible Automation Platform always runs as the control node, allowing you to automate and speed up the configuration of points of sale, WiFi access points, networking routers, ticketing systems, Internet of Things (IoT) devices, or anything with a programmatic API or Linux OS. Event-driven automation patterns can be used to communicate with relevant systems, so corresponding tickets can be updated with rich detail to provide better root cause analysis (RCA), take an action when a device comes online, or automate a follow-on action when a condition is met.

Discover edge automation industry use cases in the [Automation at the edge](#) e-book

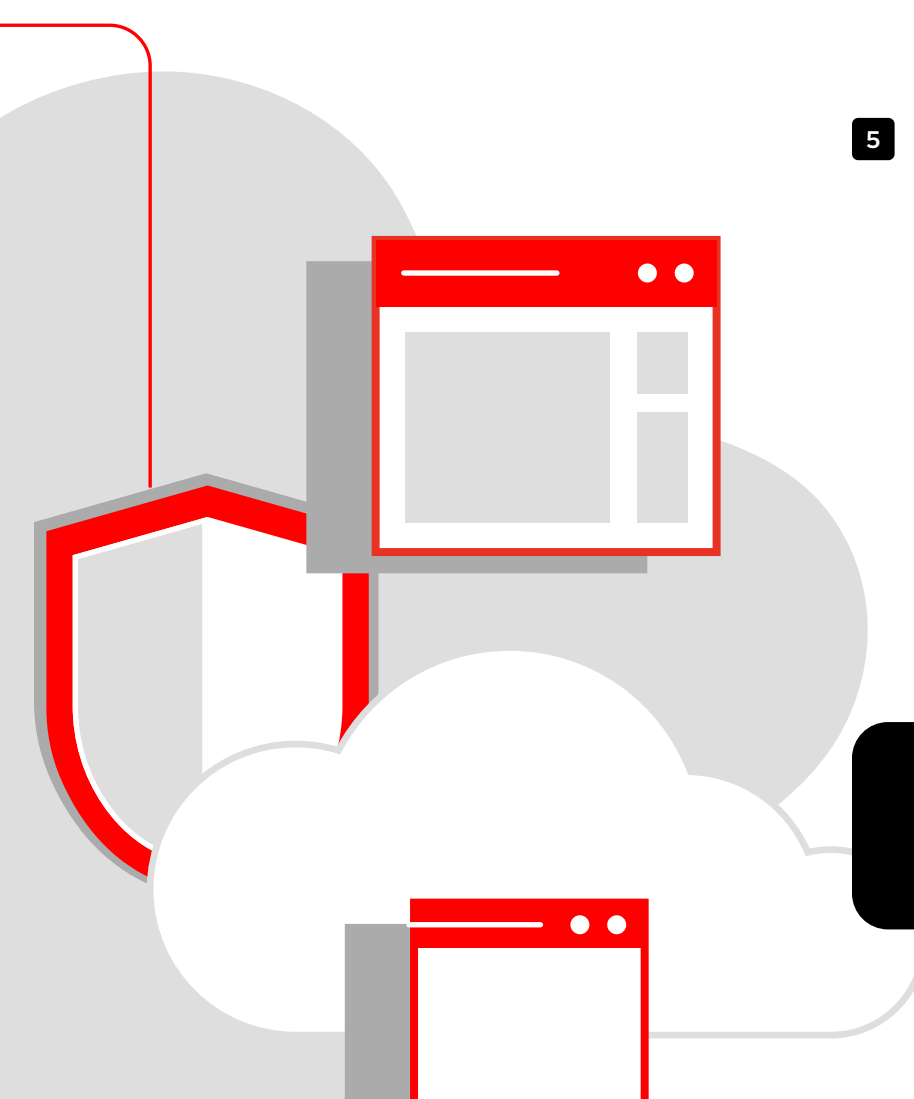



6 End-to-end enterprise automation

Ansible Automation Platform unites workflow orchestration with configuration management, provisioning, and application deployment in a single user-friendly interface, helping you deploy the platform across your organization for complete IT automation. Now with Event-Driven Ansible, there is a choice of automation modes (manually or automatically initiated) to help you meet a broader variety of needs.

Learn more about how to unify people and processes in [*The automated enterprise*](#) e-book.

7 Staying compliant and up to date

Red Hat Consulting can show you how to use automation to provide shared visibility for application, site reliability engineering, and security teams, and help you integrate the role of security more holistically across your organization. Transforming how you apply automation can include identifying, assessing, and resolving risks with prescriptive analytics; defining and enforcing security and compliance on Red Hat Enterprise Linux systems using OpenSCAP; and supporting auditing and compliance reporting with centralized content management.

Given the number of ways you can start with automation within your organization, how do you know the best place to start?

These 4 tips can help you choose the best use case for your IT environment:

1 Start small but think big.

Begin with a simple use case, ideally something that needs to be repeated often but that provides value early on. Once you get your use case working, grow and expand from there, potentially advancing to something more complicated in the same domain. Over time, add more domains. Remember, implementing automation across your organization is an iterative process, not something that's done once and forgotten about.

3 Don't begin with a broken process.

If current operational processes are inefficient, automation or AI won't make them better. Focus instead on processes that work but could be improved through automation.

2 Use, refine, learn, and expand.

Automation is a strategic imperative, so treat it as such as you implement and automate more processes and systems.

4 Involve your teams.

Automation is a journey. Allow your teams to build skills and capabilities as you grow automation throughout your organization. The more that employees can see the benefits of automation over perceived potential threats, the faster they'll embrace it. Learn more about how to get early buy-in from your teams in this interactive e-book: [The automation architect's handbook](#).

New to automation but ready to take the first step?

Jump to [How to get started](#).

Want to learn more about Ansible Automation Platform partnerships and how they contribute to Red Hat Ansible Certified Content?

[Read about their benefits.](#)

The benefits of Red Hat Ansible Automation Platform partnerships

Red Hat has built a robust ecosystem of technology partners that provide software and other products that can support your organization.

For Ansible Automation Platform, these partners are critical, as their contributions to Red Hat Ansible Content Collections help you to get up and running on the platform faster. This precomposed content—from certified partners and Red Hat—is validated against certain versions of Ansible Automation Platform and consists of bundles of modules, plug-ins, roles, and documentation, which you can consume in a single place.

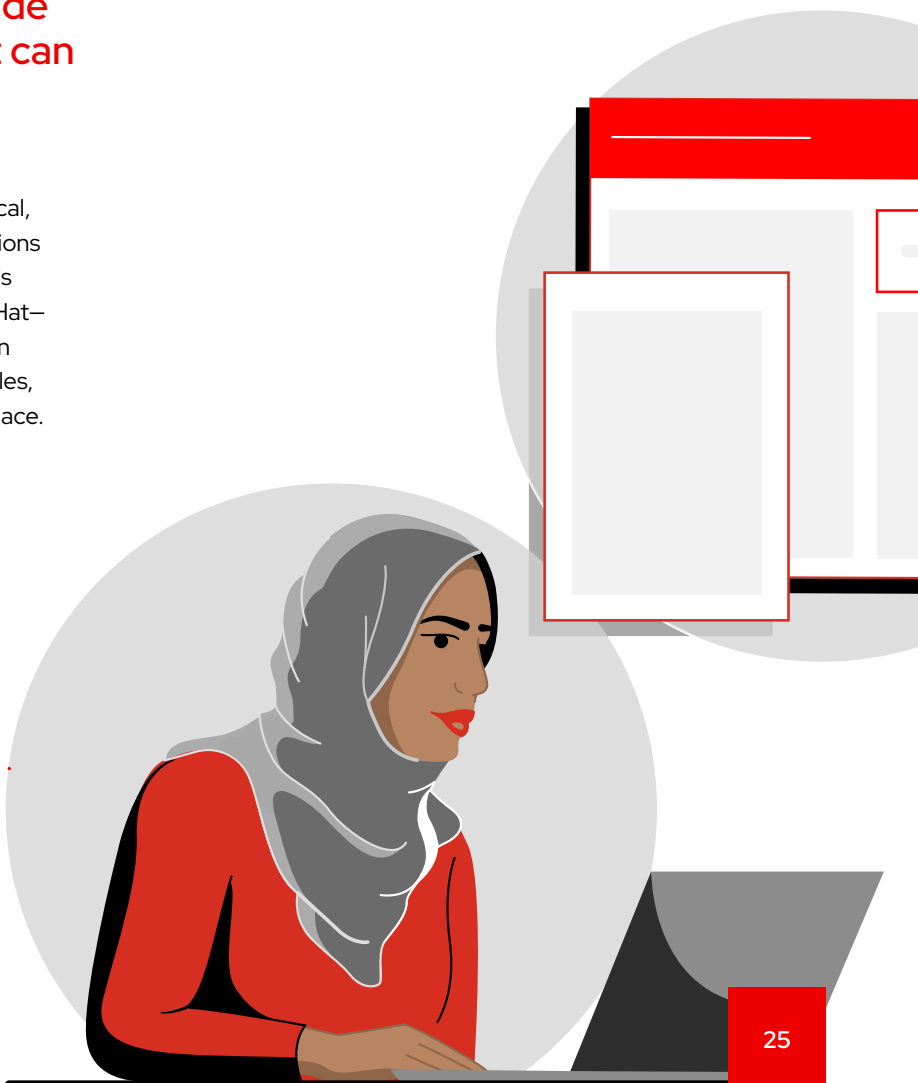

What does this mean?

You have less work to do when finding and assembling the different roles and modules you require. Plus, Ansible Content Collections are released and maintained independently of the main product versions, allowing for a faster release cadence for content.

Ansible automation hub gives you access to more than

100 certified collections

40k modules

Red Hat Ansible Certified Content in the Ansible automation hub includes collections from partners, such as

- Amazon
- Arista
- Aruba
- Cisco
- Dell
- Fortinet
- Google
- IBM
- Microsoft
- Datadog
- Dynatrace
- Splunk
- VMWare
- and many more

Explore [Red Hat Ansible Certified Content](#).

With an Ansible Automation Platform subscription, you have full access to Ansible automation hub, which has more than 100 certified content collections, comprising more than 40,000 modules curated for consistent and compliant delivery.

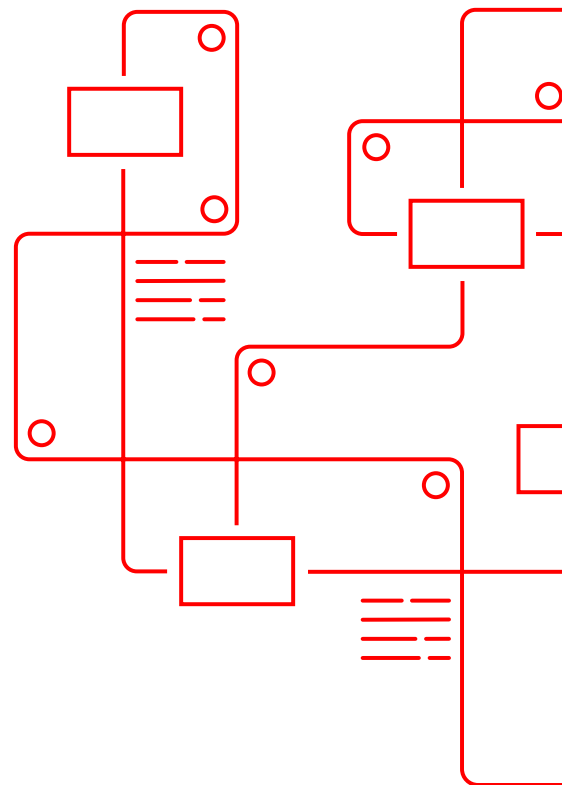

Red Hat works collaboratively with partners, including those who offer monitoring and observability tools, to advance event-driven automation solutions. Event-Driven Ansible begins with a certified content collection that often includes Event-Driven Ansible plug-ins and rulebooks for organizations to use. This includes partner-developed content that can help jumpstart new event-driven automation projects.

Strategies for automation adoption

When it comes to people, processes, and technology, the latter is often the simplest to manage within an organization: when technology operates as expected, you don't need to worry about the miscommunication or uneasiness that can sometimes arise when attempting to get your people and processes aligned with your automation adoption strategy.

Of course, people need the most care and attention when implementing any change within an organization, including new technology. Automation can cause particular concern for some employees, as there's a misconception that adopting IT automation always results in a loss of jobs. In most cases, IT automation means the elevation of work, from mundane, manual tasks to more strategic and innovative opportunities.



This transition isn't always an easy sell.

The good news is you're not alone, and there are many resources available with strategies and tips to help you gain buy-in across your organization:



Learn about the ROI, efficiencies, and other benefits that customers are realizing with Ansible Automation Platform in this [IDC whitepaper](#).



Read [Tales from the field: A system administrator's guide to IT automation](#), a compilation of short real-world stories that outline the excitement, frustrations, successes, and challenges of incorporating a holistic IT automation mindset into organizations and teams across the globe.



Discover strategies and best practices for getting buy-in for automation, from the C-suite to the IT department, in [The automation architect's handbook](#).



Learn how an IT executive can foster automation success in [The IT executive's guide to automation](#). Find out how to:

- Be a champion rather than a sponsor.
- Align to a business objective.
- Support change and collaboration.
- Encourage adoption by investing in people.



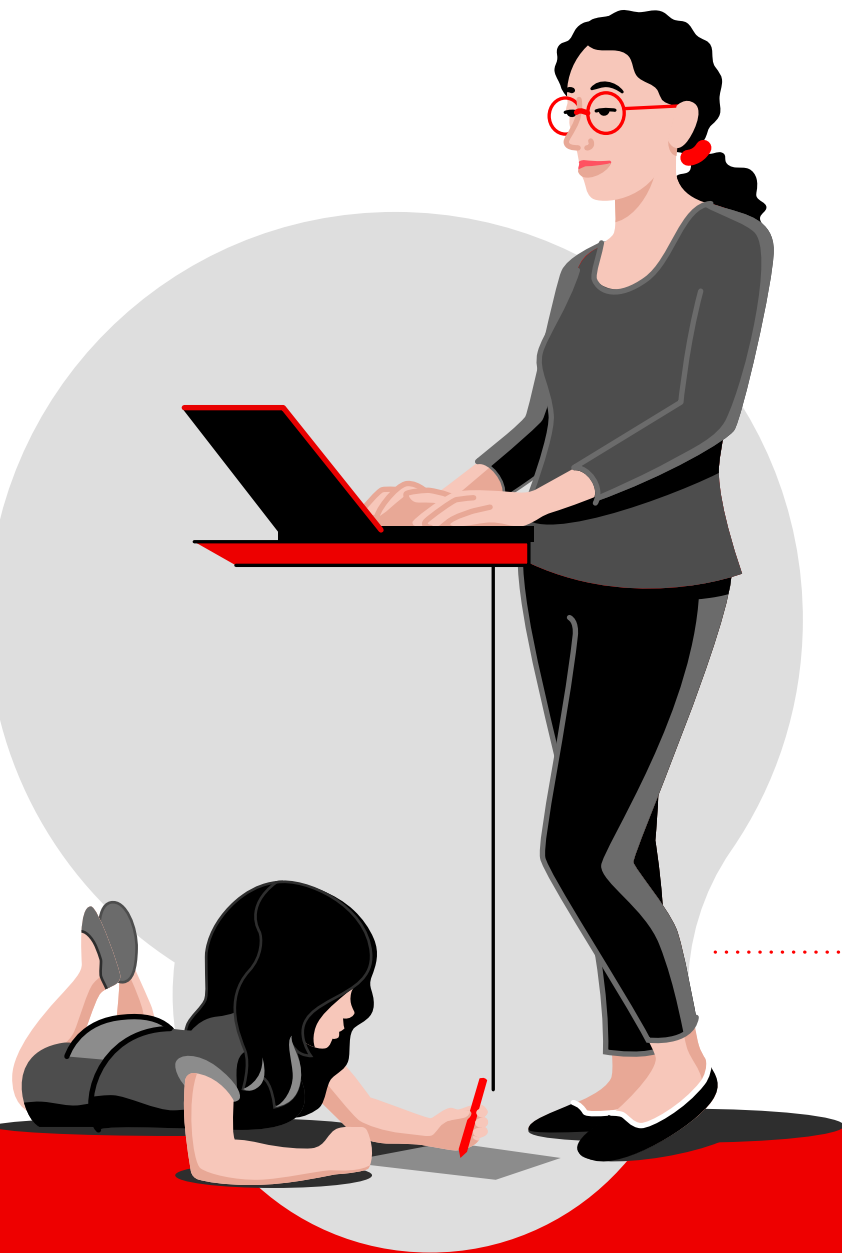

Dig into this article, [“By the numbers: Getting your team on board with IT automation,”](#) to find great tips and statistics about growing automation within your organization.



Ultimately, a team that is properly trained on automation can be a successful team. Find out what type of training your team needs on Ansible Automation Platform to either get started or advance their skills. [Red Hat Training and Certification](#) offers a wide variety of options for every skill level.

Ready to get going?

Jump to [Taking the next step](#) to find out how.

How to get started

Want to learn more about Ansible Automation Platform?

We can help.

Choose the path that's right for you.

Connect with Red Hat Consulting and accelerate your time to value through a complimentary automation [discovery session](#).

Red Hat Experts will work side by side with you to identify your business goals and challenges so they can provide an automation approach that best fits your needs.

Connect with us

Download an Ansible Automation Platform [60-day trial subscription](#) that includes Event-Driven Ansible and access to Ansible Lightspeed.

Download now

Get started with [no-cost, introductory Ansible training](#) and learn the essentials of creating, scaling, and managing automation.

Get started

Are you ready to start transforming your organization with automation?

Taking the next step



Ready to implement automation across your organization? We can help your company get started and embrace the changes it needs.

See how Red Hat Consulting can help address your use cases, assess your organizational maturity, and [evolve automation in your organization](#).

Also, consider Ansible Automation Platform training like the [Red Hat Ansible Automation Platform Boot Camp](#) to accelerate your skills as you expand your automation use. Not sure where to start? Find your place on the [Red Hat Ansible Automation Platform skills path](#).

Finally, learn how Ansible Lightspeed with IBM watsonx Code Assistant can help your teams turn automation ideas into functional Ansible code to create Ansible content more efficiently and meet organizational demands more effectively. [Learn how to use this technology](#) through a self-paced lab.

Talk to [Red Hat Technical Account Management teams](#) to help you open up collaboration with other teams, receive operational guidance, and take the next step in your automation journey.

Discover how [event-driven automation with Red Hat Ansible Automation Platform](#) technology works and how you can apply it to your IT operational challenges. Use this [interactive lab](#) to learn at your own pace about how event-driven automation can help streamline work and deliver better IT end-user experiences.

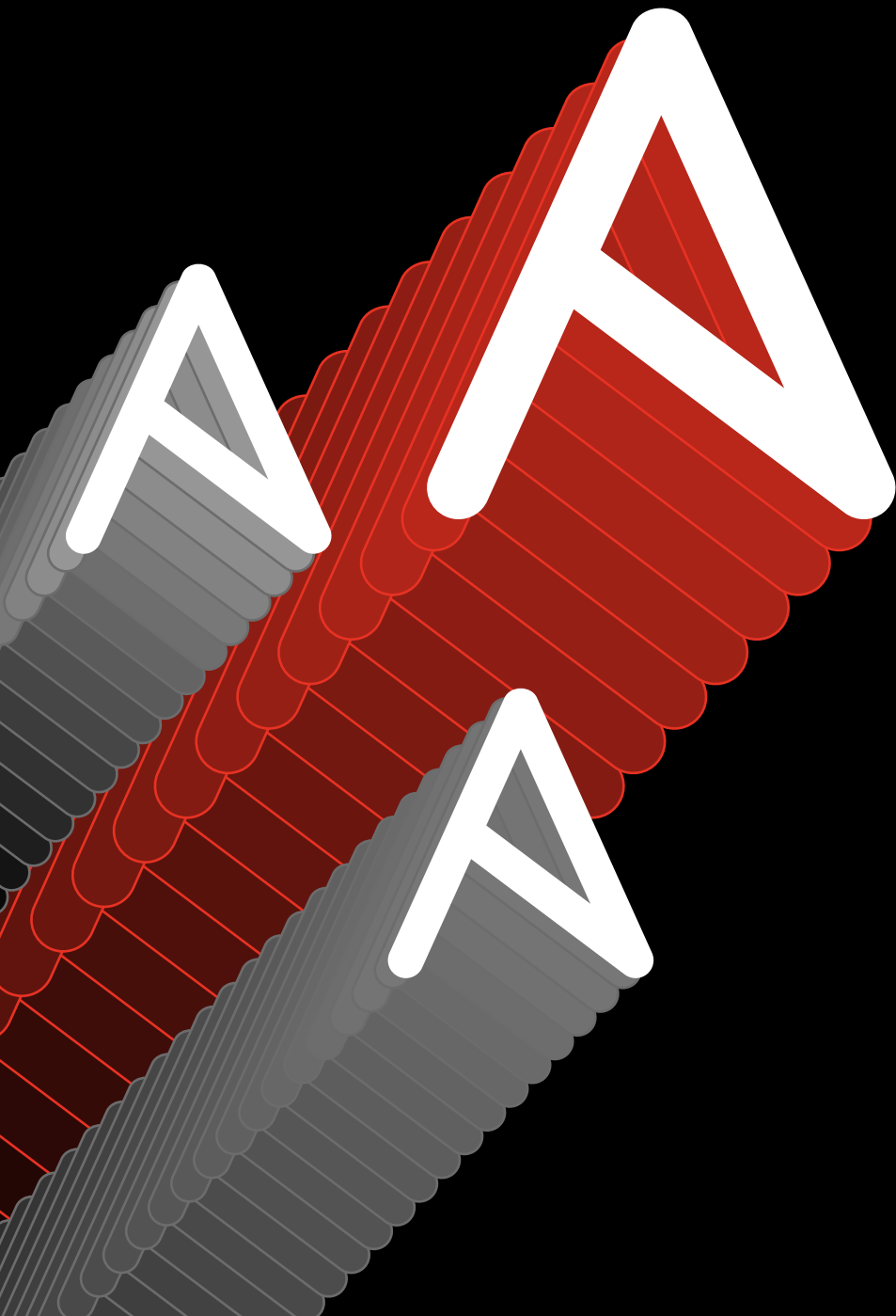

About Red Hat

Red Hat is the world's leading provider of enterprise open source software solutions, using a community-powered approach to deliver reliable and high-performing Linux, hybrid cloud, container, and Kubernetes technologies. Red Hat helps customers integrate new and existing IT applications, develop cloud-native applications, standardize on our industry-leading operating system, and automate, secure, and manage complex environments. Award-winning support, training, and consulting services make Red Hat a trusted adviser to the Fortune 500. As a strategic partner to cloud providers, system integrators, application vendors, customers, and open source communities, Red Hat can help organizations prepare for the digital future.